



Twin 5



EV Charging Stations

Installation and User Manual



| | | | | | |
|-----------|--|-----------|------------|--|-----------|
| 1. | Safety and usage instructions | 3 | 6. | Commissioning | 18 |
| 1.1 | Disclaimer | 3 | 6.1 | Safety instructions before use | 18 |
| 1.1.1 | Disclaimer public charging stations | 3 | 6.2 | Initial start-up | 18 |
| 1.2 | Improper use | 3 | 6.2.1 | Testing the sockets | 18 |
| 1.3 | Copyright | 3 | | | |
| 1.4 | Trademarks | 3 | 7. | Connectivity | 19 |
| 1.5 | Languages | 3 | 7.1 | Configuration tools | 19 |
| 1.6 | Purpose and intended audience | 3 | 7.2 | Before using the MyEve app | 19 |
| 1.7 | Explanation of text instructions used | 4 | 7.3 | Before using the ACE Service Installer | 19 |
| 1.7.1 | Safety symbols | 4 | 7.4 | Configuring the charging station | 19 |
| 1.8 | General safety | 4 | 7.4.1 | Wireless-connection | 19 |
| 1.9 | Software and complementary documentation | 4 | 7.4.2 | Wired network connection | 19 |
| | | | 7.4.3 | Backoffice management systems | 20 |
| 1.10 | Operating conditions | 5 | 8. | Maintenance | 21 |
| 2. | Product overview | 6 | 8.1 | Service | 21 |
| 2.1 | Exterior view | 6 | 8.2 | Casing cleaning procedure | 21 |
| 2.2 | Interior view | 7 | | | |
| 2.3 | Legend product overview | 8 | 9. | Disposal | 22 |
| 2.4 | Identification label | 8 | 9.1 | Decommissioning and returning | 22 |
| | | | 9.2 | Waste electrical and electronic equipment (WEEE) | 22 |
| 3. | User interface | 9 | 10. | Error codes and troubleshooting | 23 |
| 3.1 | LED indications of the Twin 5 | 9 | 11. | Technical drawings | 27 |
| 3.1.1 | Access control for local authorization (RFID cards) | 9 | | | |
| 3.1.1.1 | Installing the Master Key | 9 | | | |
| 3.1.1.2 | Adding and removing RFID cards in the local database | 9 | | | |
| 3.1.1.3 | Removing the Master Key | 10 | | | |
| 4. | Operation | 11 | | | |
| 4.1 | Payment options | 11 | | | |
| 4.1.1 | Starting and stopping the charging process with (mobile) bank card on the payment terminal | 11 | | | |
| 4.2 | Start and stop charging with RFID card | 11 | | | |
| 4.3 | Start and stop charging with Plug&Charge and Autocharge | 12 | | | |
| 5. | Installing and Connecting | 13 | | | |
| 5.1 | Safety announcements | 13 | | | |
| 5.2 | Assembly and installation requirements | 13 | | | |
| 5.2.1 | Schematic overview of charging station protection devices | 14 | | | |
| 5.3 | Preparation prior to installation | 14 | | | |
| 5.3.1 | Door locks | 14 | | | |
| 5.3.1.1 | Opening the door with dummy key | 15 | | | |
| 5.3.2 | Installation tools | 15 | | | |
| 5.4 | Scope of delivery | 15 | | | |
| 5.5 | Mechanical installation procedure | 15 | | | |
| 5.5.1 | Foundation for ground mounting | 15 | | | |
| 5.5.2 | Inserting ground cable and earth cable | 16 | | | |
| 5.5.3 | Mounting the charging station onto the base | 16 | | | |
| 5.6 | Electrical installation | 16 | | | |

1. SAFETY AND USAGE INSTRUCTIONS

1.1 Disclaimer

This document has been subjected to rigorous technical review before being published. It is revised at regular intervals, and any modifications and amendments are included in the subsequent issues. Although Alfen has made its best efforts to keep the document as precise and up-to-date as possible, Alfen does not assume any liability for defects and damage which results from the use of the information contained herein.

NOTE

This manual is subject to updates and changes. Errors and omissions excepted.

Any deviation to the products as assembled by Alfen including, but not limited to, customer-specific modifications to the product such as the placement of stickers, SIM cards or the usage of different colors (all referred to as 'Customization') may affect the final product, its experience, appearance, quality and / or lifespan (the Customized Product). Alfen is not liable for any damage to, or caused by, the Customized Product if this damage is caused by this applied Customization.

Alfen shall not be liable in any way, for any kind of damage, and the (B2B) warranty for the product and the accessories shall not apply in the following cases:

- Failure to comply with the instructions in this manual in general and with the operating conditions specifically.
- Improper use.
- External damage.
- Installation, commissioning or faulty repair or maintenance by unqualified persons.
- Failures from the grid or the GPS / mobile connectivity provider.
- Modification or configuration of the product or accessories without the knowledge of Alfen.
- Use of spare parts not approved or manufactured by Alfen.
- The charging station is used outside its operating conditions as stated in this manual.
- Situations have occurred that are beyond the control of Alfen (force majeure).
- Malfunction of an (Open Charge Point Protocol) back office.
- Damage to the electrical vehicle.

1.1.1 Disclaimer public charging stations

Alfen ICU B.V. ("Alfen") has received the explicit request to use the open area in the Alfen Twin 5 (the "EV Charger") for installing electrical components.

The on page indicated red marked area (the "Dedicated Area") may be used for the installation of electrical components within the Alfen Twin 5 (the "charging station") which charging stations are placed in the public domain if the following conditions remain to be fulfilled throughout the Warranty Period:

- The charging station shall only be opened by authorized certified electricians who shall have completed the Alfen training (an "Engineer");
- Customer shall provide explicit consent to the Engineer for the placement of components in the Dedicated Area;
- The installation, the use and operation of the charging station (EV Charger) shall always be in accordance with all applicable laws, regulations and the manuals;
- Components may only be stored in the Dedicated Area before the main switch;
- All additional installed electrical components are IP20 at minimum and installed according local installation and safety regulations and laws.

If the above conditions remain fulfilled throughout the Warranty Period, Alfen confirms that the Dedicated Area may be used and the warranty for the charging station (EV Charger) remains valid.

1.2 Improper use

Using the charging station is safe when used as intended. Any other use or changes to the charging station are considered improper use and therefore not permitted. The operator, owner or qualified technician is responsible for any personal injury or material damage arising from improper use.

1.3 Copyright

The reproduction, distribution and utilization of this document, as well as the communication of its contents to other parties without explicit authorization by Alfen N.V. or one of its affiliates, is strictly prohibited. © Alfen N.V.

1.4 Trademarks

Eve®, ICU®, Alfen® are trademarks by Alfen N.V. Any unauthorized use of the trademarks is therefore illegal.

1.5 Languages

The English version of this document is the original source. Documents in other languages are translations of this source.

1.6 Purpose and intended audience

This manual applies to the Twin 5 (in this document also indicated as "charging station") produced by Alfen ICU B.V., Hefbrugweg 79, 1332 AM Almere, the Netherlands, reg.no. 64998363 ("Alfen"). The Alfen Twin 5 is intended

1. SAFETY AND USAGE INSTRUCTIONS

exclusively for charging electric vehicles and, when installed correctly, may be used by untrained individuals. Follow this manual to install and commission the charging station correctly.

Installation, commissioning and maintenance of this charging station may only be performed by a qualified electrician. It is essential that this person has:

- Expertise on all relevant general and specific rules regarding safety and incident prevention
- Comprehensive knowledge of applicable electrical regulations.
- The ability to identify and foresee risks and avoid potential hazards
- Received and read these installation and operating instructions

1.7 Explanation of text instructions used

Safety warnings and precautions are indicated in this document as follows:

DANGER

Signal word that indicates an imminently hazardous situation that, if not avoided, will result in death or serious injury.

WARNING

Signal word that indicates a potentially hazardous situation that, if not avoided, could result in death or serious injury.

CAUTION

Signal word that indicates a potentially hazardous situation that, if not avoided, could result in minor or moderate injury.

NOTE

Signal word that provides additional information or information on possible product damage.

1.7.1 Safety symbols

The following warning pictograms are attached to (parts of) the charging station:

| Pictogram | Description |
|---|-------------------|
|  | Dangerous voltage |

| Pictogram | Description |
|---|------------------|
|  | Protective earth |

1.8 General safety

Follow the stated safety aspects when operating the charging station:

DANGER

Risk of injuries, explosion or fire. Do not use the charging station in the vicinity of explosive or highly flammable substances.

DANGER

Risk of electrocution. Do not use the charging station if it is partially submerged in water.

DANGER

Risk of injury and electrocution. Do not use the charging station if it is damaged or plugs and cables are defective. Contact the charge point operator to repair the defects immediately.

DANGER

Risk of injury and electrocution. Keep away children or individuals who are not able to assess the risks associated with using this product.

More extensive safety information is available in the relevant sections of this document.

1.9 Software and complementary documentation

NOTE

- The MyEve app notifies if a new firmware version is available.
- The ACE Service Installer does not notify if a new firmware version is available. You need to check this via the menu "Device/Upload new firmware..."

NOTE

It is possible to request a printed copy of this manual in your language by Alfen at any time. Refer to the contact information for your request.

1. SAFETY AND USAGE INSTRUCTIONS

By means of the following links you can obtain detailed information regarding the Twin 5 charging stations.

YouTube channel



providing installation, service and information videos.

[Alfen - Power to adapt](#)

Data sheet



providing detailed information on models, technical features and equipment.

[Datasheet Twin 5](#)

EU Declaration of conformity



[Declaration of conformity Twin 5](#)

Knowledge Base



providing service and procedure instructions.

[Knowledge Base](#)

Twin 5 with AHP-platform



providing firmware information, update, error codes list.

[Firmware information, update, error codes list](#)

Smart Charging configuration



for the Dutch market only

[Smart Charging Network extension module](#)

Training for Alfen charging stations



class-room trainings provided by Alfen.

[Trainings charging stations equipment](#)

Warranty



The applicable Terms & Conditions of the Alfen B2B Warranty

[B2B Warranty](#)

Alternative Fuels Infrastructure Regulation (A.F.I.R.)



providing information for the CPO on how to implement QR code payment.

[AFIR Implementation Guide](#)

1.10 Operating conditions

| | |
|-------------------------------|---------------|
| Operating temperature | -25°C to 55°C |
| Relative atmospheric humidity | 5 - 95% |
| Protection category | I |
| Degree of protection (casing) | IP54 |
| IK protection | IK10 |

2. PRODUCT OVERVIEW

2.1 Exterior view

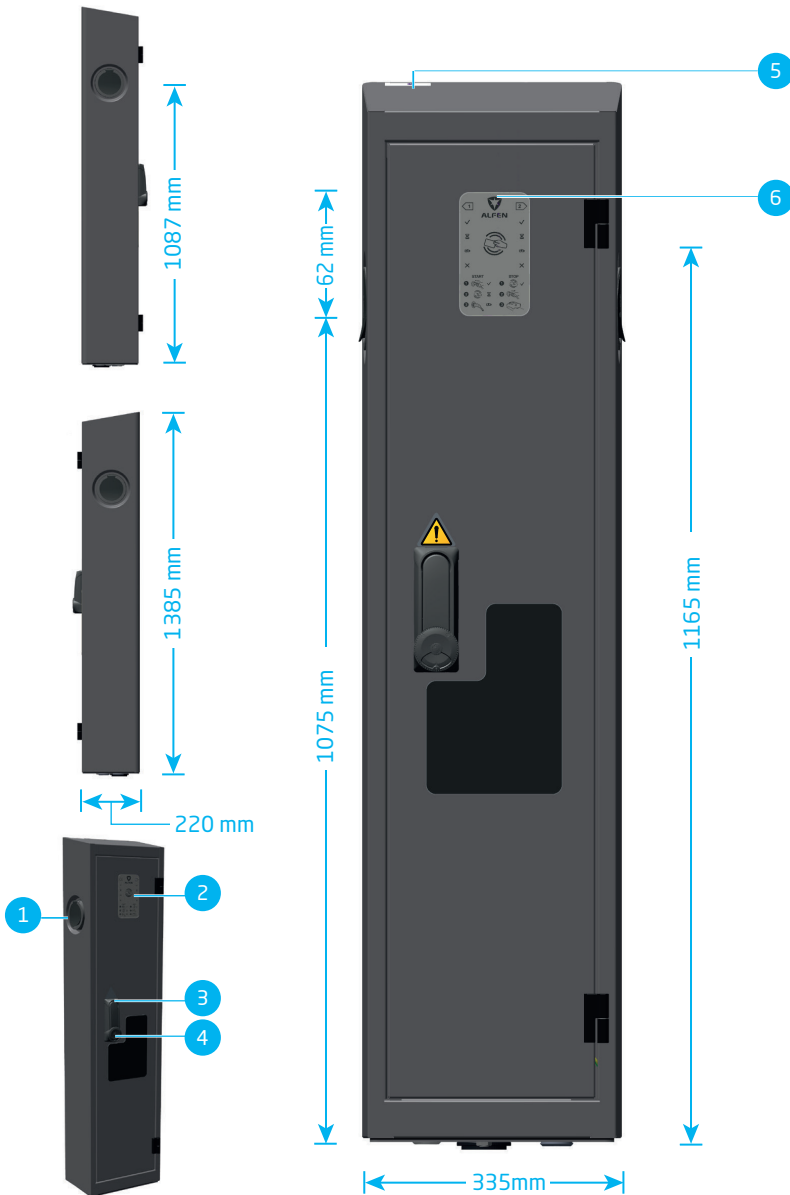

2.2 Interior view

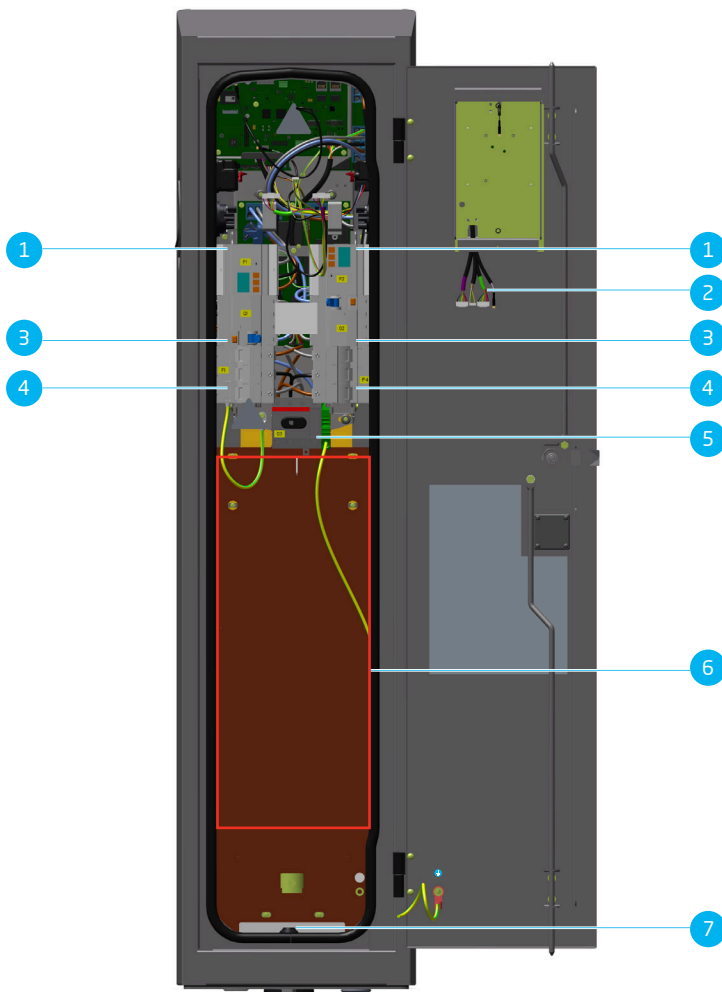

2. PRODUCT OVERVIEW

2.3 Legend product overview

Exterior view

- 1 Type 2 socket
- 2 Card reader
- 3 Door handle
- 4 Cylinder for grid operator / Cylinder for owner
- 5 Charge point Identifier (customer specific label)
- 6 Quick start instructions

Interior view

- 1 Power meter
- 2 Identification label
- 3 Type B residual current device (RCD)
- 4 Miniature circuit breaker (MCB) or fuses
- 5 Main switch
- 6 Dedicated area (refer to extended warranty installation of electronic components in chapter "Disclaimer public charging stations")
- 7 Strain relief

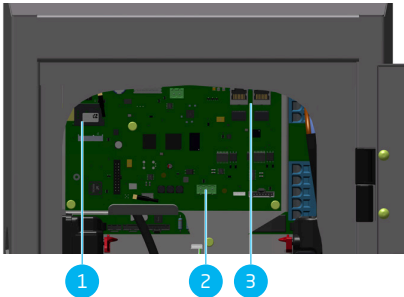

Figure 2.1: Interior view detail

No. Description

- 1 SIM card holder
- 2 External power meter connection (RS-485)
- 3 UTP / Ethernet connections

2.4 Identification label

The identification label shows the following information:



Figure 2.2: Identification label

No. Description

- 1 OCPP charge point model name (consisting of the platform name and the last five digits of the article number)
- 2 Type / Article number
- 3 Object number (unique number per charging station)
- 4 Production date
- 5 Technical specifications (such as the number of phases, maximum charging current and voltage)

NOTE

When contacting your charge point supplier / operator, always have your type / article number and object number available to facilitate quick support.

3.1 LED indications of the Twin 5

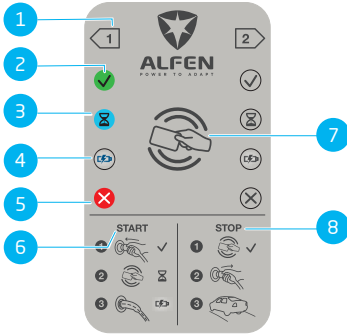

Figure 3.1: Display of the charging station with LED's (left socket active in this illustration)

| No. | Description |
|-----|--|
| 1 | Socket indication |
| 2 | RFID card accepted, cable connected |
| 3 | Communication with vehicle or charging completed |
| 4 | Charging in progress |
| 5 | Error message |
| 6 | Operating steps to start the charging process |
| 7 | RFID reader |
| 8 | Operating steps to stop the charging process |

3.1.1 Access control for local authorization (RFID cards)

To control local user access to an Alfen charging station, install a RFID card as the 'Master key'. With this Master Key, you can grant access to other RFID cards for using your charging station.

NOTE

Your charging station must be configured correctly in order to accept Master Keys.

3.1.1.1 Installing the Master Key

1. Select a RFID card, like the included Alfen RFID card.
2. Hold the RFID card in front of the RFID reader for 10 seconds.

3. After 10 seconds, the RFID card will be registered as the Master Key. The following icon appears on the screen:



NOTE

The charging station does not recognize the RFID card and will give a warning first. Ignore the warning.

NOTE

The charging station will only recognize one RFID card as the Master Key.

Once the Master Key is registered, it can be used to add or remove RFID cards from the local database.

3.1.1.2 Adding and removing RFID cards in the local database

For every RFID card held in front of the charging station, a sound signal will be given. Follow the on-screen instructions to manage access control:

NOTE

The Master Key cannot be used for charging. It is only used for access control of the charging station.

1. Hold the Master key in front of the RFID reader



2. Hold the RFID card you wish to add in front of the RFID reader. The following symbol is displayed:



3. Hold the RFID card you wish to remove in front of the RFID reader. The following symbol is displayed.



4. To close the database, hold the Master Key again in front of the RFID reader.

3. USER INTERFACE

NOTE

If you have added or removed a RFID card in error, you can immediately hold it in front of the RFID reader to undo the action.

NOTE

To prevent the local database from being 'open' to access control, the menu will close automatically if no card has been detected or removed after 10 seconds. The symbol will disappear from the display.

3.1.1.3 Removing the Master Key

A Master key can only be removed using the MyEve app or the ACE Service Installer. If necessary, you can ask for help from one of our technicians. This might, however, incur costs. Therefore, always keep the Master key in a safe location.

4.1 Payment options

4.1.1 Starting and stopping the charging process with (mobile) bank card on the payment terminal

1. In order to authorize the payment,
 - present your (mobile) bank card to the card reader of the payment terminal.
2. Connect the charging cable to start the charging process. During charging the status indication on the charging station shows the progress. Charging will stop automatically when the battery has been charged completely.
3. When charging is completed or when you wish to stop the transaction:
 - present your (mobile) bank card to card reader of the payment terminal.
4. Unplug the charging cable.
5. The bank statement of the transaction will contain a link to the detailed information about the charging session. If you provided an email address, the charge point operator will send an invoice (with the link) to the email address.

NOTE

The payment service provider settles the costs of the transaction.

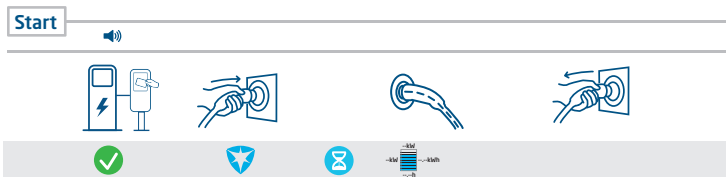

Figure 4.1: Customer Journey: Paying on payment terminal

4.2 Start and stop charging with RFID card

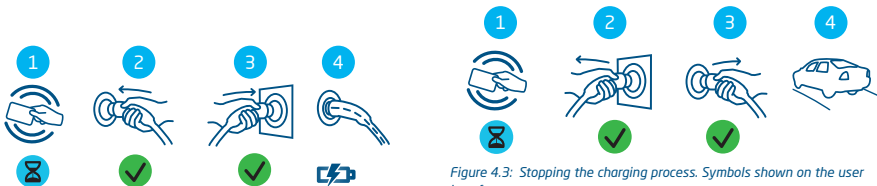

Figure 4.2: Starting the charging process with user authorization / RFID card. Symbols shown on the user interface

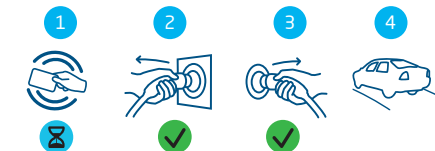

Figure 4.3: Stopping the charging process. Symbols shown on the user interface

| No. | Description |
|-----|---|
| 1 | Scan the RFID card on the charging stations RFID reader |
| 2 | Plug the charging cable into the charge point |
| 3 | Plug the charging cable into the car |
| 4 | Charging in progress |

| No. | Description |
|-----|---|
| 1 | Scan the RFID card on the charging stations RFID reader |
| 2 | Remove the charging cable from the charge point |
| 3 | Remove the charging cable from the car |
| 4 | Leave the charging place |

4. OPERATION

4.3 Start and stop charging with Plug&Charge and Autocharge

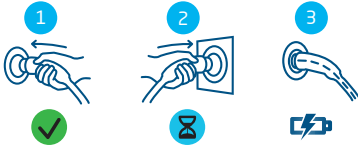

Figure 4.4: Starting the charging process without RFID card. Symbols shown on user interface

No. Description

- 1 Plug the charging cable into the car
- 2 Plug the charging cable into the charge point
- 3 Charging in progress

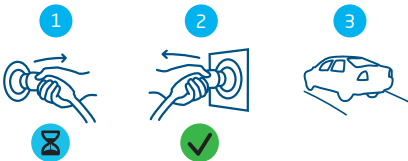

Figure 4.5: Stopping the charging process without RFID card. Symbols shown on user interface

No. Description

- 1 Remove the charging cable from the car
- 2 Remove the charging cable from the charge point
- 3 Leave the charging place

5.1 Safety announcements

⚠ DANGER

Risk of injury and electrocution. Installation, (de)commissioning and maintenance of the charging station may only be performed by a qualified electrician.

⚠ DANGER

Risk of injury and electrocution. Installing the charging station incorrectly may result in fatal injury! When working with electricity, failure to comply with relevant regulations can lead to dangerous and life-threatening situations.

⚠ DANGER

Risk of electrocution. The electrical system must be disconnected from every power source before performing any installation or maintenance work!

⚠ DANGER

Risk of injury and electrocution. The charging station contains electrical components that still contain a charge after being disconnected from the system. Always test with proper equipment that there is no residual current before starting to work.

⚠ WARNING

Risk of injuries, explosion or fire. Never install in a potentially explosive atmosphere.

⚠ WARNING

Risk of electrocution. Never install in areas prone to flooding without implementing compensatory measures.

⚠ WARNING

Risk of injury and electrocution. Installation work may not be carried out during rain or if the air humidity exceeds 95%.

⚠ WARNING

Risk of injury and electrocution. The installation must be performed by a qualified electrician who has read this manual and will execute the installation in accordance with the IEC 60364 (Electrical Installations for Buildings) standard.

⚠ WARNING

Risk of damage or electrocution. A charging station must always be installed on separate power circuit.

⚠ WARNING

Risk of damage or electrocution. Local conditions may affect the installation requirements. Your installation must comply with the standards and regulations of the location (country) where it is installed.

⚠ CAUTION

Risk of injury and damage. The installer is always responsible for choosing the correct cable diameter and complying with the relevant standards and legislation.

⚠ CAUTION

Risk of injury and damage. The installation and cables should be installed to match the maximum charging current to the input of the charging station. This should assume continuous load.

⚠ CAUTION

Risk of injury and damage. Mechanical impact and/or collisions might cause damage to the equipment. Protect Alfen products installed in public areas and car park sites.

⚠ CAUTION

Risk of damage. Adapters or conversion adapters are not allowed to be used.

5.2 Assembly and installation requirements

When selecting a location to install the charging station, the following criteria must be met:

- Always fully comply with local technical requirements and safety regulations
- An on-site connection has been prepared that complies with the specifications of the charging station.
- The installation site must have a leveled and solid foundation or, if the charging station is installed into the ground, preparing the foundation is part of the installation process.
- A maximum temperature difference within 24 hours of < 35 °C

Please refer to the following table for safety options and cable cross-sections advised.

5. INSTALLING AND CONNECTING

Power supply cable: minimum advised cable cross-section (based on assumed max. 50 m cable length)

- 11 kW charging, 16 A selected per phase: 5 x 4 mm²
- 22 kW charging, 32 A selected per phase: 5 x 6 mm²
- Maximum cross-section: 35 mm²

Short-circuit protection:

- Integrated in grid connection box (in case of direct installation to grid), or
- Installation on the local low-voltage distributor:
- With circuit breakers: 40 A, 3-pole, type B or C
- With fuses: 3 x 80 A gG. In case of gG fuses it is possible to use 64 A maximum

Earth leakage protection:

- 30 mA RCB Type B

Nominal input voltage:

- VL₁-N: 230 V (+/-10%)
- VL₂-N: 230 V (+/-10%)
- VL₃-N: 230 V (+/-10%)
- VL₁-L₂: 400 V (+/-10%)
- VL₁-L₃: 400 V (+/-10%)
- VL₂-L₃: 400 V (+/-10%)
- VPE-N: ≈ 0 V

Nominal frequency:

- 50 Hz

Grounding:

- TN system: PE cable
- grounding electrode < 100 Ohm spreading resistance
- IT system: connected to a shared reference (common earth) with other metal parts

5.2.1 Schematic overview of charging station protection devices

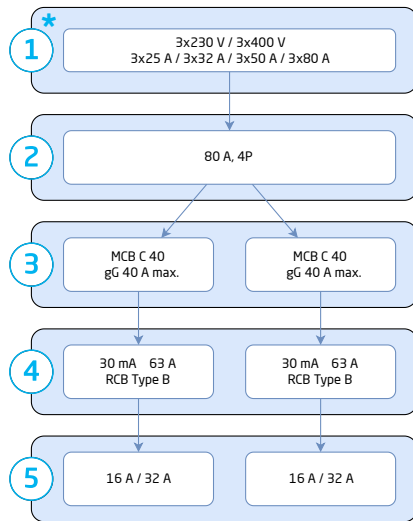

| Position | Indication |
|----------|--------------------------------------|
| 1* | Grid connection box or CAM (*option) |
| 2 | Main switch |
| 3 | Short circuit protection |
| 4 | Residual current protection |
| 5 | Sockets |

5.3 Preparation prior to installation

- View the site and determine the installation location.
- Check the scope of delivery and required parts.
- Read this installation manual before hand.

5.3.1 Door locks

The door handle of the charging station can be equipped with 2 locks (depending on scope of delivery):



- 1 left lock for owner of charging station
- 2 right lock for grid operator

5.3.1.1 Opening the door with dummy key

If no cylinders are provided in the opening, open the charging station door with the provided plastic dummy key as follows:

1. Insert the provided (plastic) dummy key into one of the openings and turn.

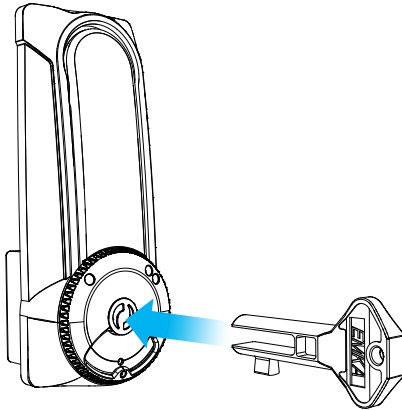

NOTE

If you insert the dummy key into the left opening, turn it *counterclockwise* to unlock the handle.

2. Pull the handle upwards to open the door.

5.3.2 Installation tools

- Level
- Shovel
- Stanley knife

- Phillips screwdriver
- Wire stripper
- Socket set / spanners

5.4 Scope of delivery

The scope of delivery provides:

- Charging station
- Installation manual and assembly supplies
- Cable pipe
- RFID card(s)
- Charge point password

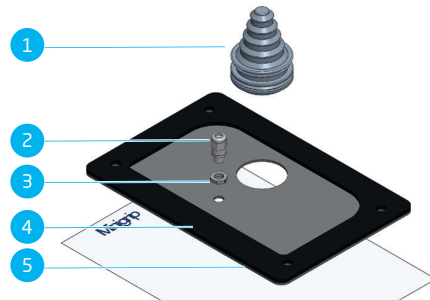

Figure 5.1: Bottom plate with mounting material

| No. | Description | Quantity |
|-----|---|----------|
| 1 | Grommet for main power supply | 1 |
| 2 | Grommet for earthing cable | 1 |
| 3 | Connection nut | 1 |
| 4 | Base plate gasket (taped to base plate) | 1 |
| 5 | Base plate | 1 |

5.5 Mechanical installation procedure

5.5.1 Foundation for ground mounting

1. Dig a hole of approx. 500 x 500 mm and 550 mm deep and level out horizontally.
2. Position the base and level it.
3. Place the supplied cable glands and cutting glands on the sealing plate. Place the whole assembly on the bottom of the charging station

5. INSTALLING AND CONNECTING

4. Provide an earth electrode or earth pin, depending on the local regulations.

5.5.2 Inserting ground cable and earth cable

1. Make a provision in the form of a main grounding rail right at the bottom of the charging station to ground the charging station. (This applies to both: a PE cable and an earthing pin)
2. Pass the ground cable through the conduit, concrete base and tulle in the gasket / base plate assembly.
3. Leave an overhang from the top of the base of at least 250 mm. Due to the mounting of the strain relief it is recommended to cut the cable only when the charging station is mounted on the base.
4. Pass the earthing cable, coming from the earthing pin, through the gasket / base plate assembly.

5.5.3 Mounting the charging station onto the base

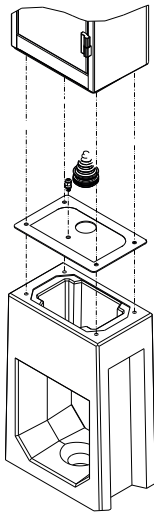

Figure 5.2: Exploded view of charging station to be mounted on base

1. Insert four threaded M10 x 80 mm rods into the sockets on the base.
2. Place the gasket / baseplate assembly over the threaded ends.

3. Place the charging station on the base over the wire ends and over the power supply cable and ground cable.
4. Cut the cable grommet to size, so that the power supply cable is firmly clamped in place.
5. Guide the power supply cable through the bottom plate. Pull the power supply cable to the outside of the charging station to fit the strain relief provided.
6. Mount the strain relief.
7. Guide the power supply cable back into the charging station / base. Make sure that 250 mm cable length remains in the charging station.
8. Fasten the charging station to the base as shown in figure with the provided 4 M10 nuts including lock and V-rings.
9. Secure the charging station to the base with 4 M10 x 80 mm studs.

5.6 Electrical installation

1. Remove the sheath from the power cable with a Stanley knife and remove the sheaths from the loose wires with a wire stripper.
2. Connect the earth pin.
3. The earthing sleeve / earthing wire of the distribution system operator may only be used as an earthing device with the written consent of the system operator;
4. According to your installation requirements, make sure the grounding resistance of the system is set to one of the following values:
 - a. < 100 Ohm (requirement by EV/ZE Ready 1.4I certification);
 - b. < 167 Ohm (requirement Dutch NEN1010 standard);
 - c. According to the values stated in the legal regulations of your country.
5. According to product variant disconnect the charging station from voltage source:
 - a. Make sure the main switch is in the OFF (0) position, or
 - b. Make sure the main residual current circuit breaker (RCCB) is in the OFF (0) position

-
6. According to product variant disconnect the charging station from voltage source:
 - a. Remove the fuses in the distribution system operator cabinet of the charging station, or
 - b. Switch the circuit breakers (MCB) to the OFF (0) position;

 7. According to product variant:
 - a. Connect the wires of the phases to the fuse holders, or
 - b. to the circuit breakers (MCB) in the distribution system operator cabinet of the charging station including standard grid connection. (PE on separate rail)

 8. Connect the provided cable clamp to the plate provided at the back wall inside of the charging station (see figure 2.2 and 2.3 position 7) ensuring strain relief on the cable.

 9. According to product variant connect the charging station to voltage source:
 - a. Place fuses (if supplied) in the fuse holders and close the holders, or
 - b. Switch the circuit breakers (MCB) to the ON (I) position.
 - c. Switch on the external power supply.

 10. According to product variant connect the charging station to voltage source:
 - a. Make sure the main switch is in the ON (I) position, or
 - b. Make sure the main residual current circuit breaker (RCCB) is in the ON (I) position.

 11. If a transparent cover is supplied for the internal components, fit it with the bolts supplied.

 12. Close the door and make sure it is securely locked.

6. COMMISSIONING

6.1 Safety instructions before use







1. Make sure the charging station is properly connected to the power supply as described in this manual.
2. Make sure the distribution of the power supply is separately protected by an appropriate breaker (automatic or fuse cartridges)
3. Make sure the charging station is installed in accordance with this manual.
4. Make sure the casing is always closed during normal operation.

6.2 Initial start-up

1. Turn on the local power supply.
The charging station will now run self diagnostics. All interface LED's will flash briefly. The following background operations will occur within a few seconds:
 - The sockets are tested one by one (locking and unlocking).
 - The internal relays are tested: audible by clicking noise.
 - The  symbols will flash twice.

The charging station is now ready for testing.

6.2.1 Testing the sockets

1. Put the test charging cable in one of the sockets.
The  symbol illuminates. The hourglass symbol  flashes.
2. Hold the RFID card in front of the RFID reader to start charging.
The  symbol flashes. Then the hourglass symbol  illuminates and the charging symbol  illuminates. The socket is now functional.
3. Hold the RFID card in front of the RFID reader to stop charging.
The hourglass symbol  illuminates. The  symbol illuminates.
4. Pull out the test charging cable.
The socket is now ready for use.
5. Do the same procedure for the other socket.

7.1 Configuration tools

The charging station can be accessed and configured:

- via the MyEve app
- via the ACE Service Installer

The app will guide you step-by-step through the configuration process.

7.2 Before using the MyEve app

NOTE

The MyEve app is designed to be used exclusively by the installer / electrician. Its purpose is to commission and configure Alfen charging stations.

The MyEve app is not intended for end users of the charging station.

1. Download the MyEve app in Google Play Store or Apple App Store to your laptop, tablet or smartphone.



Google Play Store



Apple App Store

2. You will be requested to create an account.
3. If you have the MyEve app installed, make sure you update to the latest version. Use the above QR-codes to see if your MyEve app needs to be updated.
4. Make sure the security settings on your laptop, tablet or smartphone are not blocking the MyEve app.

7.3 Before using the ACE Service Installer

1. Download the ACE Service Installer from the Alfen website to your laptop:

<https://alfen.com/en-gb/search-downloads>

2. Request an account at this e-mail address: ace.aftersales@alfen.com.

NOTE

It may take some days until you receive the login-data.

3. If you have the ACE Service Installer installed, make sure you have the latest version. If updates are available, you will be asked to update when you log in.

4. Make sure the firewall settings on your device are not blocking the ACE Service Installer.

7.4 Configuring the charging station

7.4.1 Wireless-connection

How to establish a wireless (Wi-Fi) connection between your device and the charging station:

NOTE

Currently the communication between the MyEve app and the charging station is only possible via a wired connection.

1. Download the MyEve app on your device. The device can be a smartphone, tablet or laptop.
2. Create an account in the MyEve app and log in.
3. Choose one of the two options below to connect your device:
 - a. Connect directly to the Wi-Fi network of the charging station.
 - b. Connect to the same local area network (LAN) the charging station is connected to.
4. Find your newly installed charging station in the list of newly discovered devices.
5. Enter the password provided on the password card supplied with the charging station. You can use the QR-code on the password card instead of manually entering the password.
The network connection has now been established. Via the MyEve app you can configure the settings.
6. After finishing the configuration, hand over the card with password (recovery) information to the end user.

7.4.2 Wired network connection

How to establish a wired network connection by connecting the charging station to your device using an UTP (Ethernet) cable:

The minimum requirement is a CAT5 UTP (Ethernet) cable

7. CONNECTIVITY

NOTE

When using a smartphone or tablet an adapter such as a USB-C to Ethernet or Lightning to Ethernet is required.

1. Log in to the MyEve app or the ACE Service Installer.
 2. Connect the UTP (Ethernet) cable to your router or directly to the charging station.
 3. Connect the UTP (Ethernet) cable with the corresponding port.
 4. Connect your device to the switch or router or directly to the charging station.
 5. Select your charging station from the list in the MyEve app or the ACE Service Installer.
-

NOTE

If the charging station(s) is (are) not detected automatically, the MyEve app or the ACE Service Installer might be blocked by the security settings on your laptop, tablet or smartphone. Check the settings of your laptop, tablet or smartphone and try again.

6. Enter the password provided on the password card supplied with the charging station. The QR-code on the password card can be used for the MyEve app. The network connection has now been established. Via the MyEve app or the ACE Service Installer you can configure the settings
 7. After finishing the configuration, hand over the card with password (recovery) information to the end user.
-

7.4.3 Backoffice management systems

If additional services by a backoffice provider have been purchased, the charging station has been configured ex-factory to connect to the selected backoffice management system.

NOTE

A connection with a backoffice management system can only be established if arrangements with the supplier of this system have been made. The service of third parties is not provided by Alfen.

NOTE

If the charging station is set to connect with a backoffice management system, it will do so directly and automatically.

NOTE

Manually configuring and connecting to a backoffice management system can be done with the MyEve app. A SIM card needs to be installed during installation. If you do not have a SIM card, please contact your backoffice provider.

NOTE

If a mobile communication (SIM card) Internet connection has been purchased, the charging station is already equipped with a SIM card and will automatically connect, once the charging station is being commissioned.

⚠ DANGER

Risk of injury and electrocution. Installation, (de)commissioning and maintenance of the charging station may only be performed by a qualified electrician.

Alfen recommends to carry out preventive maintenance once a year at public charging stations.

💡 NOTE

Contact your Sales Manager to find out about the possibilities for service contracts including preventive maintenance.

8.1 Service

The charging stations are serviced by the local charge point supplier. Your charge point supplier provides support to you. When contacting your charge point supplier, always have the serial number of your charging station available to facilitate quick support. Optionally you can find support for all our products on knowledge.alfen.com.

8.2 Casing cleaning procedure

💡 NOTE

The casing of the charging station can be damaged. Do not use any aggressive cleaning agents, high-pressure cleaner, scouring pads or similar.

1. Fully close the charging station as described in the instructions before any cleaning procedure.
2. Annual cleaning:
 - Use water and mild soap to clean the casing of the charging station.
3. Annual polishing:
 - If applicable, polish metal parts of the charging station using wax suitable for cars. Be cautious not to damage the casing.

9. DISPOSAL

9.1 Decommissioning and returning

WARNING

Risk of injury and electrocution. Installation, (de)commissioning and maintenance of the charging station must only be performed by a qualified electrician.

For returning charging equipment to Alfen Charging Equipment, create a 'Request for Service' ticket at support.alfen.com.

For further instructions, see [How do I return a charging station to have it repaired in Alfen's manufacturing facility \(Carry-in\)?](#) You will receive all shipping instructions within the ticket.

9.2 Waste electrical and electronic equipment (WEEE)









Electrical and electronic equipment contains materials, components and substances that may be hazardous and present a risk to human health and the environment if not handled correctly.





Equipment marked with the illustrated crossed out wheeled bin is electrical and electronic equipment. The crossed out wheeled bin indicates that this waste must be collected separately and must not be discarded together with household waste.

Refer to your local authority for collection schemes under which residents can dispose waste electrical and electronic equipment at a recycling center or other collection points.

10. ERROR CODES AND TROUBLESHOOTING

| Code | Error message displayed | Icon | Possible cause | Possible countermeasures |
|--------------------------------|---|---|---|--|
| General error | | | | |
| 001 | Not able to charge. Please call for support. |  | Unknown general error. | Contact the service department of your charge point supplier. |
| Charging station related error | | | | |
| 101 | One moment please. Your charging session will resume shortly. |  | DC fault current (>6mA) detected by charging station. | <ul style="list-style-type: none"> One specific vehicle: Contact your car dealership. Multiple vehicles: Contact the service department of your charge point supplier. |
| 102 | Not able to charge. Please call for support. |  | Internal error. Unexpected or no voltage on output of power board. | <ul style="list-style-type: none"> Contact the service department of your charge point supplier. Check powerboard. |
| 104 | Not able to charge. Please call for support. |  | Internal error. Voltage too low on internal power supply (power board). | <ul style="list-style-type: none"> Contact the service department of your charge point supplier. Check powerboard. |
| 105 | Not able to charge. Please call for support. |  | Internal error. No communication with internal power meter. | <ul style="list-style-type: none"> Contact the service department of your charge point supplier. Check if internal power meter is configured correctly. Check internal power meter. |
| 106 | Not able to charge. Please call for support. |  | Power interrupted by internal RCD. | <ul style="list-style-type: none"> Contact your installation engineer. Internal RCD (Type A: 30 mA AC) tripped. |
| 108 | Not displayed. | Not displayed. | Charging station configured as Plug & Charge authorization mode and Plug & Charge ID is not configured. | <ul style="list-style-type: none"> Contact the service department of your charge point supplier. Configure Plug & Charge ID. |
| 109 | Not displayed. | Not displayed. | No connection / connection lost to card reader. | <ul style="list-style-type: none"> Contact the service department of your charge point supplier. Check if the card reader is connected correctly. |
| Installation related error | | | | |
| 201 | Error in installation. Please check installation or call for support. |  | Protective earth not connected or unstable. | <ul style="list-style-type: none"> Contact your installation engineer. Recommended earth resistance of the installation < 100 Ohm. |







10. ERROR CODES AND TROUBLESHOOTING

| Code | Error message displayed | Icon | Possible cause | Possible countermeasures |
|------|--|---|---|---|
| 202 | Input voltage too low, not able to charge. Please call your installer. |  | Supply voltage below 210 VAC. | Contact your installation engineer. |
| 206 | Temporary set to unavailable. Contact CPO or try again later. |  | Charging station is set to inoperative by the charge point operator / the charging station is updating. | Contact your charge point operator. <ul style="list-style-type: none"> Firmware update in progress. |
| 208 | Not displayed. | Not displayed. | Supply voltage above 275 VAC. | <ul style="list-style-type: none"> Contact the service department of your charge point supplier. Check voltage levels. |
| 209 | Not displayed. | Not displayed. | No connection / connection lost to DSMR4.x / SMR5.0 (P1) smart energy Meter. | <ul style="list-style-type: none"> Contact the service department of your charge point supplier. Check DSMR4.x / SMR5.0 (P1) smart energy Meter connection. |
| 210 | Not displayed. | Not displayed | No connection / connection lost to Modbus TCP/IP energy meter / energy management system. | <ul style="list-style-type: none"> Contact the service department of your charge point supplier. Check Modbus TCP/IP energy meter / energy management system. |
| 211 | Not able to lock cable. Please call for support. |  | Unable to move locking motor during build-in self-test. | <ul style="list-style-type: none"> Contact your installation engineer. Check if locking motor is connected correctly. Check if locking motor can move. |
| 212 | Error in installation. Please check installation or call for support. |  | Missing phase in installation. | <ul style="list-style-type: none"> Contact your installation engineer. Check voltage levels. |
| 213 | Not displayed. | Not displayed. | No connection / connection lost to TIC smart energy Meter. | <ul style="list-style-type: none"> Contact the service department of your charge point supplier. Check TIC smart energy Meter connection. |
| 214 | Not able to charge. Please call for support. |  | Tariffs not configured, required for ad-hoc payments with Eichrecht. | <ul style="list-style-type: none"> Contact your charge point operator. Tariffs not configured (StartPrice & EnergyPrice). |

Vehicle related error

| | | | | |
|-----|--|---|--|--|
| 301 | One moment please your charging session will resume shortly. |  | Unknown error in communication with car. | <ul style="list-style-type: none"> Check car and charging cable. Otherwise contact the service department of your charge point supplier. |
|-----|--|---|--|--|

10. ERROR CODES AND TROUBLESHOOTING

| Code | Error message displayed | Icon | Possible cause | Possible countermeasures |
|---|--|---|---|---|
| 302 | One moment please your charging session will resume shortly. |  | Safety measure, Vehicle draws more power than allowed / did not reduce power in time according to the IEC 61851 standard. | <ul style="list-style-type: none"> • One specific vehicle: Contact your car dealership. • All vehicles: Contact the service department of your charge point supplier. |
| 303 | One moment please your charging session will resume shortly. |  | Safety measure, vehicle has started and stopped charging to often within 1 minute. | <ul style="list-style-type: none"> • Check car and charging cable. • Otherwise contact the service department of your charge point supplier. |
| 304 | Charging not started yet to continue please reconnect cable. |  | Cable connected for more than 2 minutes without starting a charging session. | <ul style="list-style-type: none"> • Reconnect cable and start charging session within 2 minutes. • Otherwise contact the service department of your charge point supplier. |
| Ambient or equipment related error (user, plug, cable, weather conditions etc.) | | | | |
| 401 | Inside temperature high. Charging will resume shortly. |  | Temperature inside the charge point above 70 degrees Celsius. | <p>Unexpected:</p> <ul style="list-style-type: none"> • Ambient temperature. • No EV charging. <p>Contact the service department of your charge point supplier.</p> <p>Expected:</p> <ul style="list-style-type: none"> • Ambient temperature. • Installed in direct sunlight. • EV charging. <p>Contact your installation engineer.</p> |
| 402 | Inside temperature low. Charging will resume shortly. |  | Temperature inside the charge point below -40 degrees Celsius. | <ul style="list-style-type: none"> • Unexpected ambient temperature. <p>Contact the service department of your charge point supplier.</p> <ul style="list-style-type: none"> • Expected ambient temperature. |
| 404 | Not able to lock cable. Please reconnect cable. |  | Unable to lock the charging cable. | <p>Contact the service department of your charge point supplier.</p> <ul style="list-style-type: none"> • Check socket and charging cable plug. • Check if the lock motor can move freely. |
| 405 | Cable not supported. Please try connecting your cable again. |  | Measure PP resistance of the charging cable is out of range according to the IEC 61851 standard. | <ul style="list-style-type: none"> • One specific cable: Issues with other charge points. <p>Cable broken</p> <ul style="list-style-type: none"> • All cables: No issue with other charge point. <p>Contact the service department of your charge point supplier.</p> |

10. ERROR CODES AND TROUBLESHOOTING

| Code | Error message displayed | Icon | Possible cause | Possible countermeasures |
|------|--|---|---|---|
| 406 | No communication with vehicle. Please check your charging cable. |  | Monitored CP voltage level is out of range according to the IEC 61851 standard. | <ul style="list-style-type: none">• One specific cable: Issues with other charge points.• Cable broken• All cables: No issue with other charge point. Contact the service department of your charge point supplier. |
| 407 | Not displayed. | Not displayed. | | |

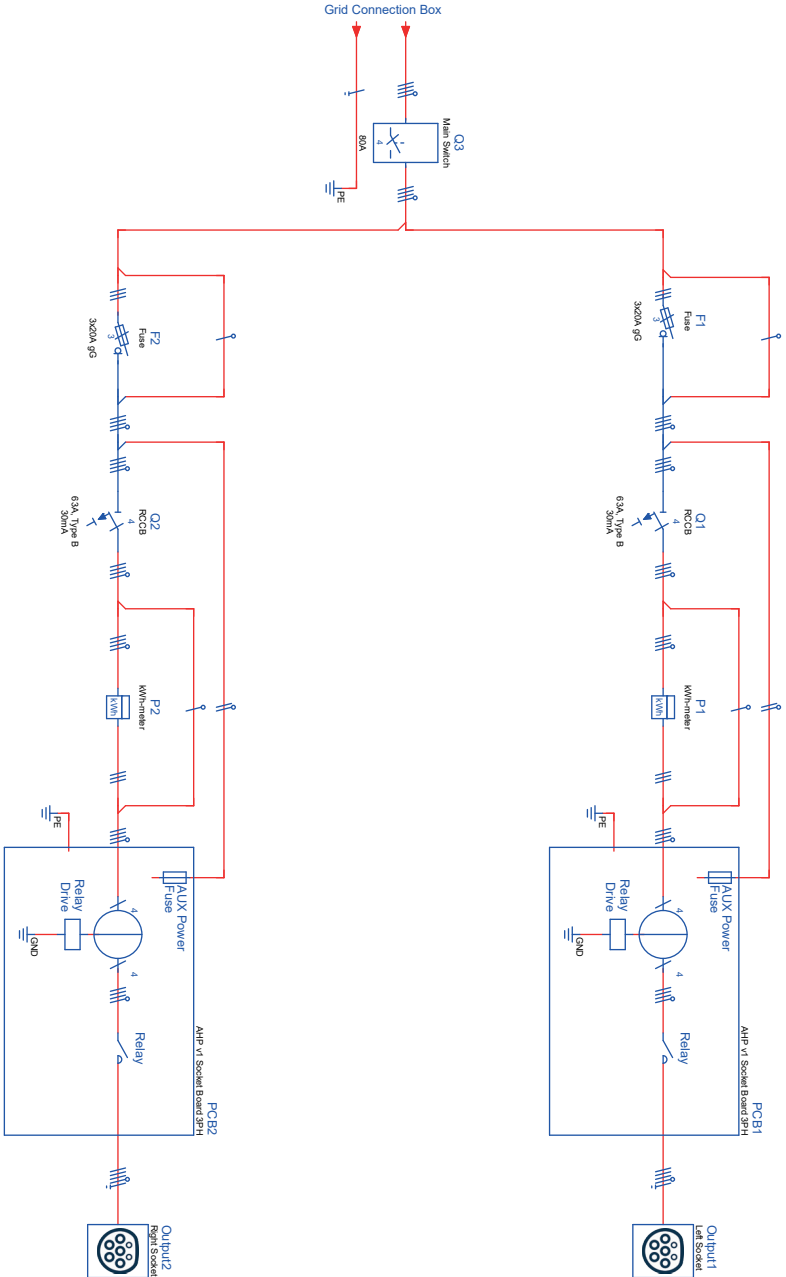

Contact

Alfen ICU B.V.
Hefbrugweg 79
1332 AM Almere
The Netherlands

P.O. box 1042
1300 BA Almere
The Netherlands

Alfen Knowledge Base: knowledge.alfen.com
Alfen Service Portal: aftersales.alfen.com
Tel. Service: +31 (0)36 54 93 402
Website: alfen.com

